

STANDARD RECOVERY DIODES

Stud Version

Features

- Wide current range
- High voltage ratings up to 3200V
- High surge current capabilities
- Stud cathode and stud anode version
- Standard JEDEC types

600A

Typical Applications

- Converters
- Power supplies
- Machine tool controls
- High power drives
- Medium traction applications

Major Ratings and Characteristics

Parameters	SD600N/R		Units
	04 to 20	25 to 32	
$I_{F(AV)}$	600	600	A
@ T_C	92	54	°C
$I_{F(RMS)}$	940	940	A
I_{FSM} @ 50Hz	13000	10500	A
@ 60Hz	13600	11000	A
I^2t @ 50Hz	845	551	$K A^2s$
@ 60Hz	772	503	$K A^2s$
V_{RRM} range	400 to 2000	2500 to 3200	V
T_J	-40 to 180	-40 to 150	°C

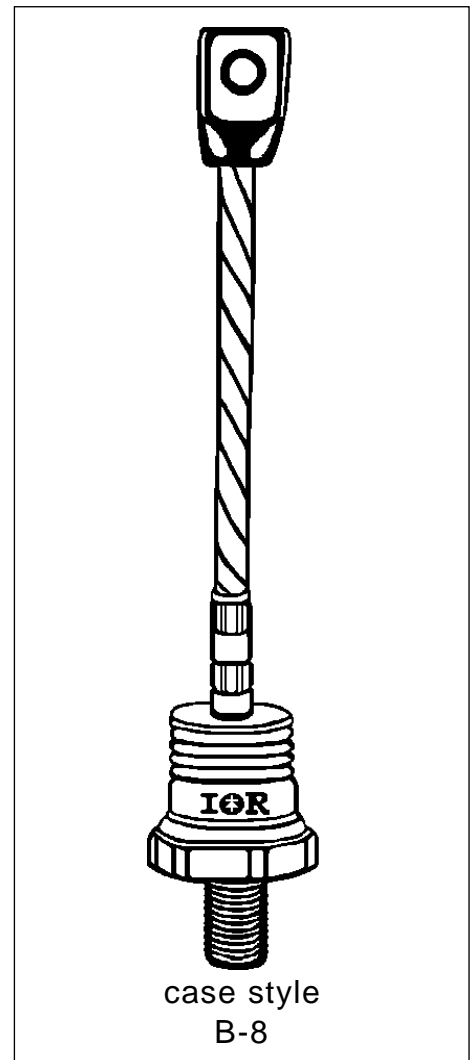

SD600N/R Series

ELECTRICAL SPECIFICATIONS

Voltage Ratings

Type number	Voltage Code	V_{RRM} , maximum repetitive peak reverse voltage V	V_{RSM} , maximum non-repetitive peak rev. voltage V	I_{RRM} max. @ $T_J = T_J$ max. mA
SD600N/R	04	400	500	35
	08	800	900	
	12	1200	1300	
	16	1600	1700	
	20	2000	2100	
	25	2500	2600	
	28	2800	2900	
	32	3200	3300	

Forward Conduction

Parameter	SD600N/R		Units	Conditions		
	04 to 20	25 to 32				
$I_{F(AV)}$ Max. average forward current @ Case temperature	600	600	A	180° conduction, half sine wave		
	92	54	°C			
$I_{F(AV)}$ Max. average forward current @ Case temperature	570	375	A	180° conduction, half sine wave		
	100	100	°C			
$I_{F(RMS)}$ Max. RMS forward current	940	940	A	DC @ $T_C = 75^\circ\text{C}$ (04 to 20), $T_C = 36^\circ\text{C}$ (25 to 32)		
I_{FSM} Max. peak, one-cycle forward, non-repetitive surge current	13000	10500	A	t = 10ms	No voltage	Sinusoidal half wave, Initial $T_J = T_J$ max.
	13600	11000		t = 8.3ms	reapplied	
	10900	8830		t = 10ms	100% V_{RRM}	
	11450	9250		t = 8.3ms	reapplied	
I^2t Maximum I^2t for fusing	845	551	KA ² s	t = 10ms	No voltage	
	772	503		t = 8.3ms	reapplied	
	598	390		t = 10ms	100% V_{RRM}	
	546	356		t = 8.3ms	reapplied	
$I^2\sqrt{t}$ Maximum $I^2\sqrt{t}$ for fusing	8450	5510	KA ² √s	t = 0.1 to 10ms, no voltage reapplied		
$V_{F(TO)1}$ Low level value of threshold voltage	0.78	0.84	V	(16.7% x π x $I_{F(AV)}$) < I < (π x $I_{F(AV)}$), $T_J = T_J$ max.		
$V_{F(TO)2}$ High level value of threshold voltage	0.87	0.88		(I > π x $I_{F(AV)}$), $T_J = T_J$ max.		
r_{f1} Low level value of forward slope resistance	0.35	0.40	mΩ	(16.7% x π x $I_{F(AV)}$) < I < (π x $I_{F(AV)}$), $T_J = T_J$ max.		
r_{f2} High level value of forward slope resistance	0.31	0.38		(I > π x $I_{F(AV)}$), $T_J = T_J$ max.		
V_{FM} Max. forward voltage drop	1.31	1.44	V	$I_{pk} = 1500\text{A}$, $T_J = T_J$ max, $t_p = 10\text{ms}$ sinusoidal wave		

Thermal and Mechanical Specifications

Parameter	SD600N/R		Units	Conditions
	04 to 20	25 to 32		
T_J Max. junction operating temperature range	-40 to 180	-40 to 150	°C	
T_{stg} Max. storage temperature range	-55 to 200	-55 to 200		
R_{thJC} Max. thermal resistance, junction to case	0.1		K/W	DC operation
R_{thCS} Max. thermal resistance, case to heatsink	0.04			Mounting surface, smooth, flat and greased
T Max. allowed mounting torque $\pm 10\%$	50		Nm	Not lubricated threads
wt Approximate weight	454		g	
Case style	B-8			See Outline Table

 ΔR_{thJC} Conduction

(The following table shows the increment of thermal resistance R_{thJC} when devices operate at different conduction angles than DC)

Conduction angle	Sinusoidal conduction	Rectangular conduction	Units	Conditions
180°	0.012	0.008	K/W	$T_J = T_J \text{ max.}$
120°	0.014	0.014		
90°	0.017	0.019		
60°	0.025	0.026		
30°	0.042	0.042		

Ordering Information Table

Device Code																	
	<table border="1" style="margin: auto;"> <tr> <td style="background-color: black; color: white; padding: 5px;">SD</td> <td style="background-color: black; color: white; padding: 5px;">60</td> <td style="background-color: black; color: white; padding: 5px;">0</td> <td style="background-color: black; color: white; padding: 5px;">N</td> <td style="background-color: black; color: white; padding: 5px;">32</td> <td style="background-color: black; color: white; padding: 5px;">P</td> <td style="background-color: black; color: white; padding: 5px;">S</td> <td style="background-color: black; color: white; padding: 5px;">C</td> </tr> <tr> <td style="text-align: center;">①</td> <td style="text-align: center;">②</td> <td style="text-align: center;">③</td> <td style="text-align: center;">④</td> <td style="text-align: center;">⑤</td> <td style="text-align: center;">⑥</td> <td style="text-align: center;">⑦</td> <td style="text-align: center;">⑧</td> </tr> </table>	SD	60	0	N	32	P	S	C	①	②	③	④	⑤	⑥	⑦	⑧
SD	60	0	N	32	P	S	C										
①	②	③	④	⑤	⑥	⑦	⑧										
1	- Diode																
2	- Essential part number																
3	- 0 = Standard recovery																
4	- N = Stud Normal Polarity (Cathode to Stud) R = Stud Reverse Polarity (Anode to Stud)																
5	- Voltage code: Code x 100 = V_{RRM} (See Voltage Ratings table)																
6	- P = Stud base B-8 3/4" 16UNF-2A M = Stud base B-8 M24 X 1.5																
7	- S = Isolated lead with silicone sleeve (Red = Reverse Polarity; Blue = Normal Polarity) T = Threaded Top Terminal 3/8" 24UNF-2A None = Non isolated lead																
8	- C = Ceramic Housing																
NOTE: Available for rotating applications (Contact factory)																	

SD600N/R Series

Outlines Table

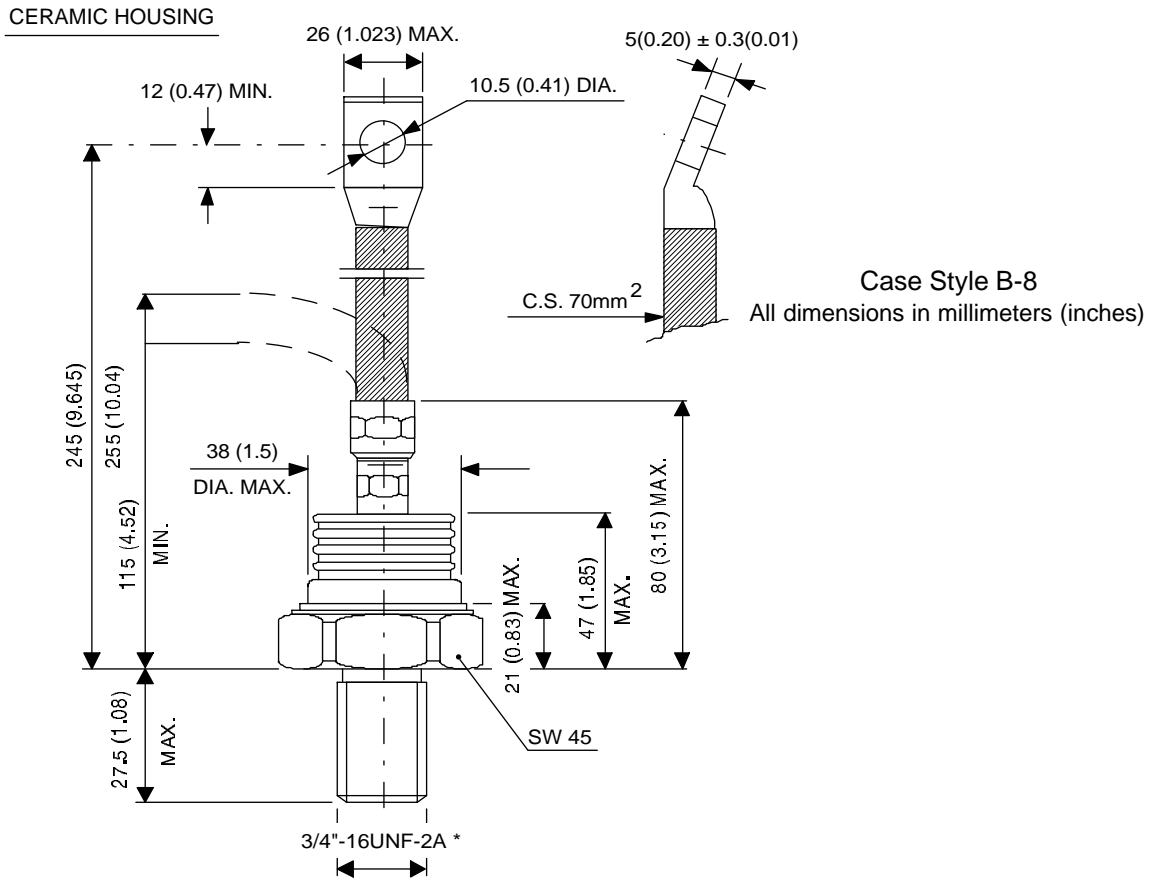

* FOR METRIC DEVICE: M24 x 1.5 - SCREW LENGTH — 21(0.83) MAX.

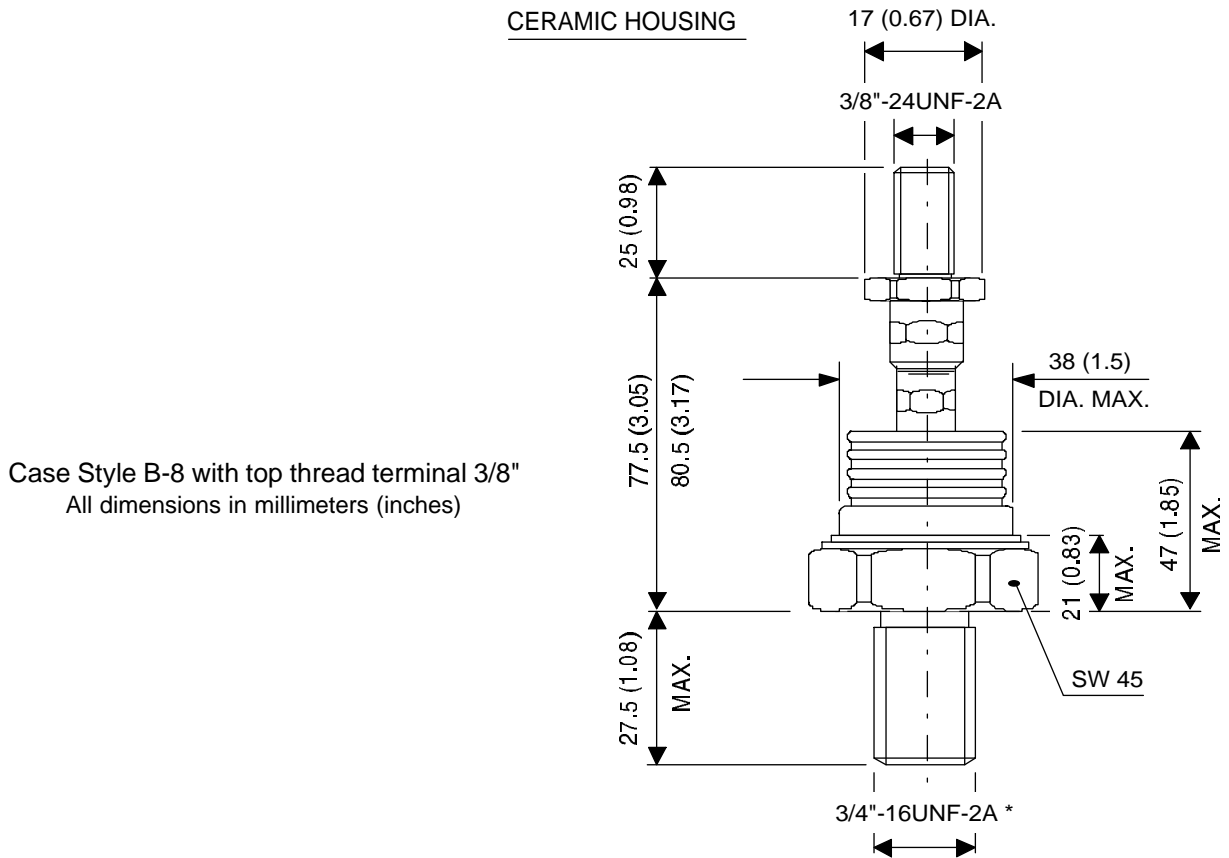

* FOR METRIC DEVICE: M24 x 1.5 - SCREW LENGTH — 21(0.83)

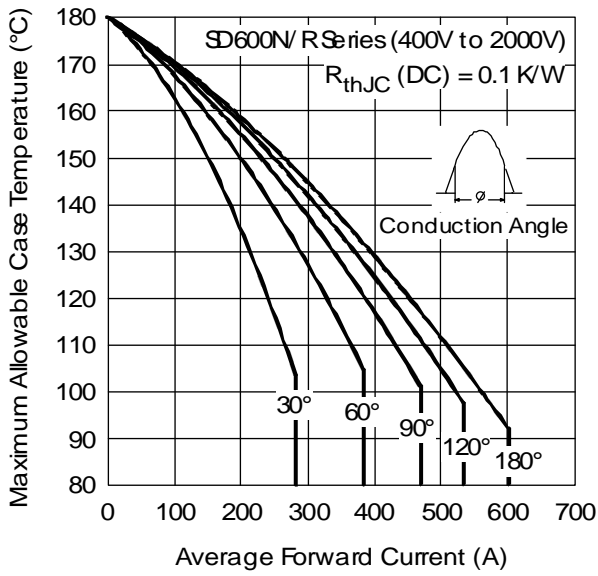

Fig. 1 - Current Ratings Characteristics

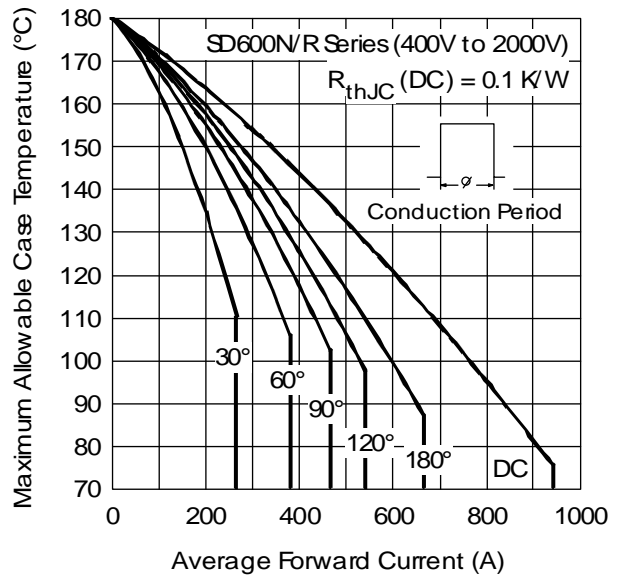

Fig. 2 - Current Ratings Characteristics

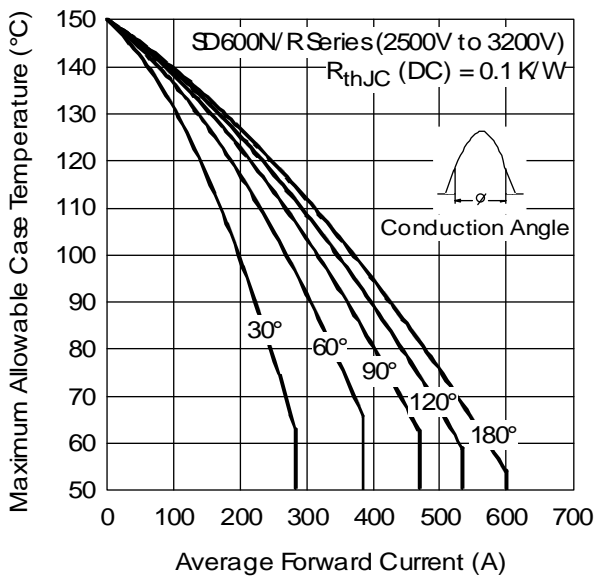

Fig. 3 - Current Ratings Characteristics

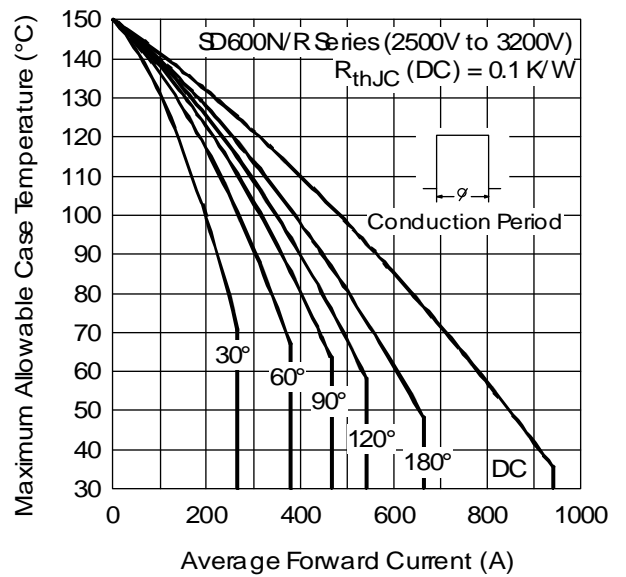

Fig. 4 - Current Ratings Characteristics

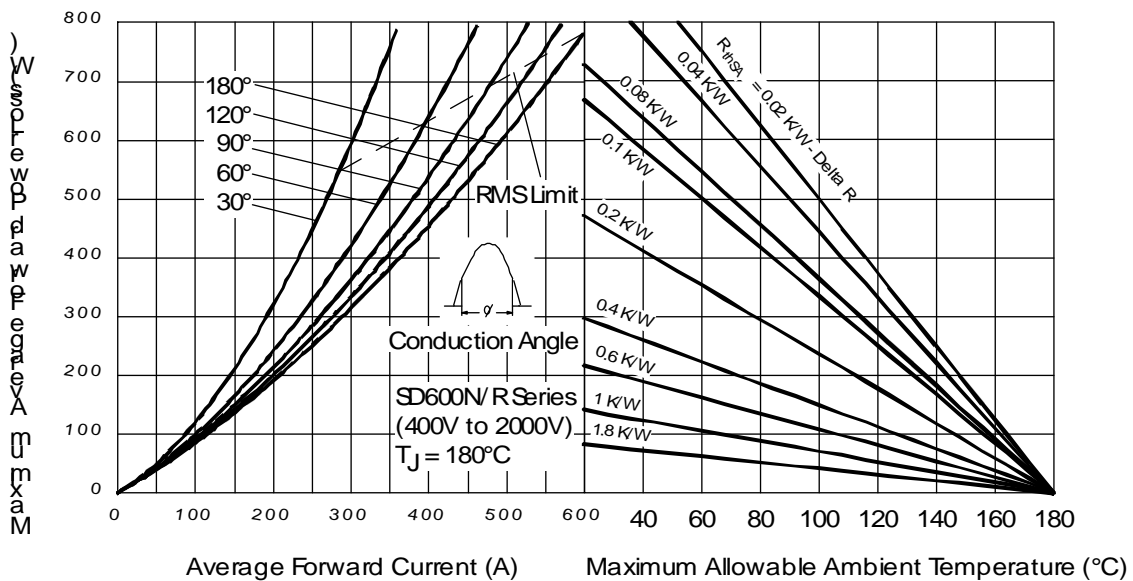

Fig. 5 - Forward Power Loss Characteristics

SD600N/R Series

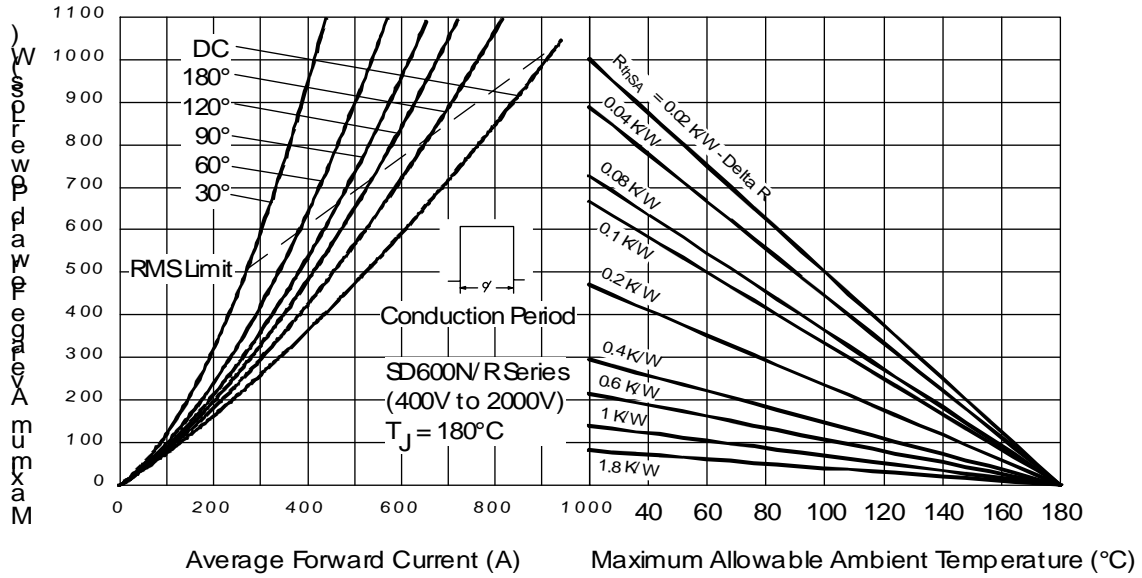

Fig. 6 - Forward Power Loss Characteristics

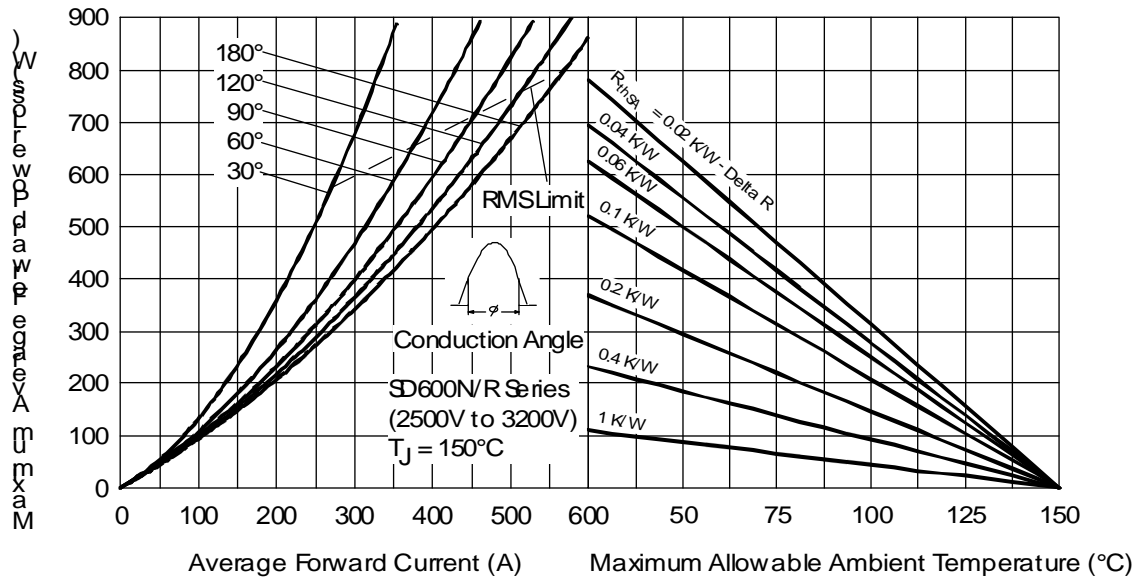

Fig. 7 - Forward Power Loss Characteristics

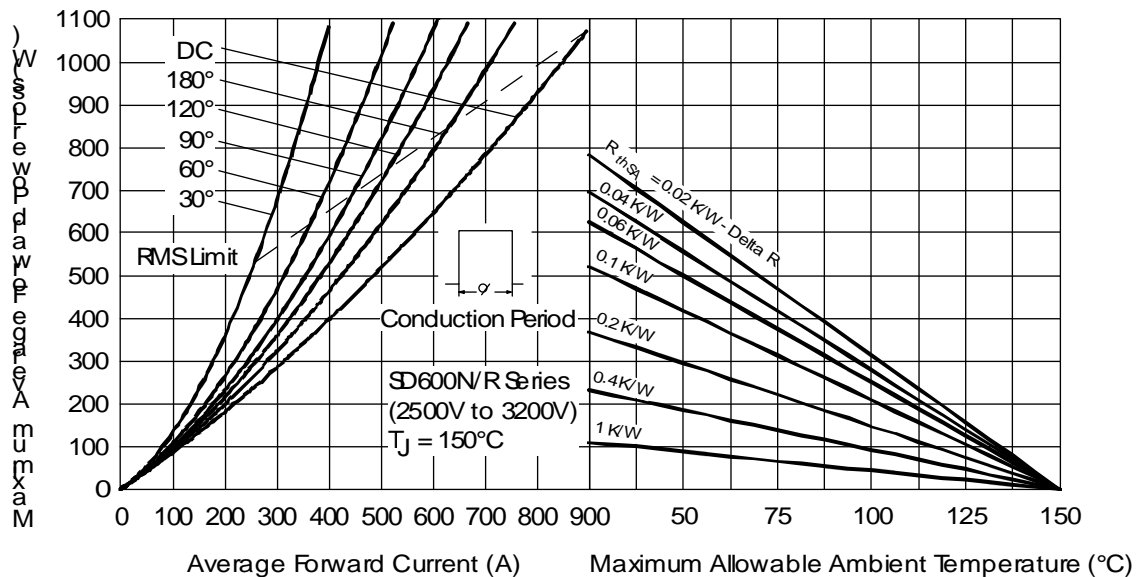

Fig. 8 - Forward Power Loss Characteristics

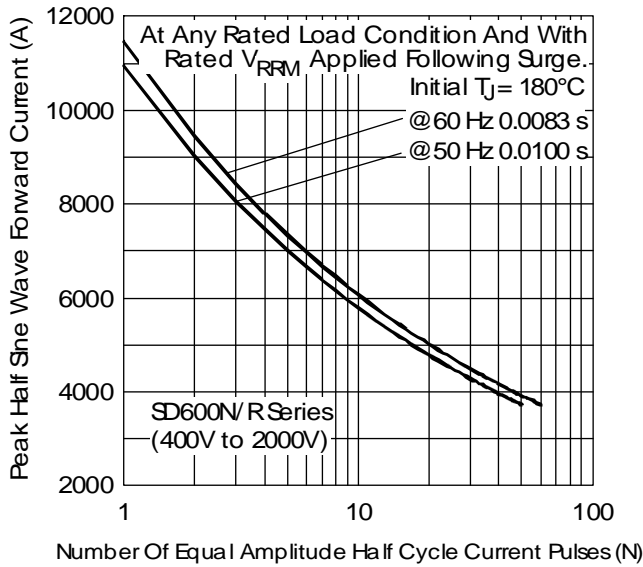

Fig. 9 - Maximum Non-Repetitive Surge Current

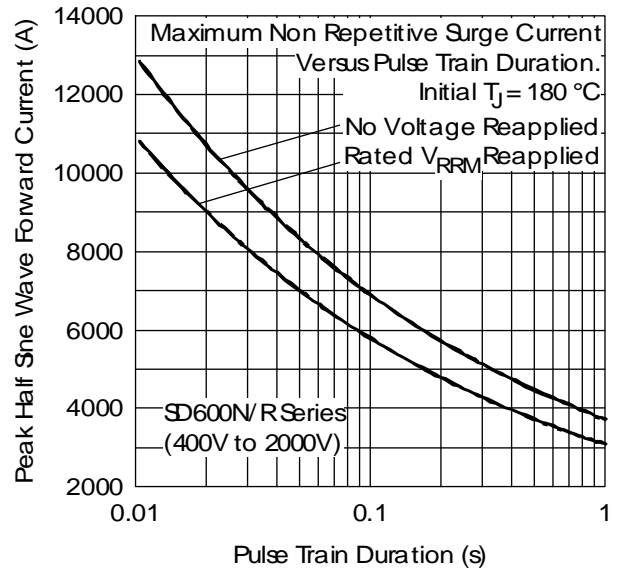

Fig. 10 - Maximum Non-Repetitive Surge Current

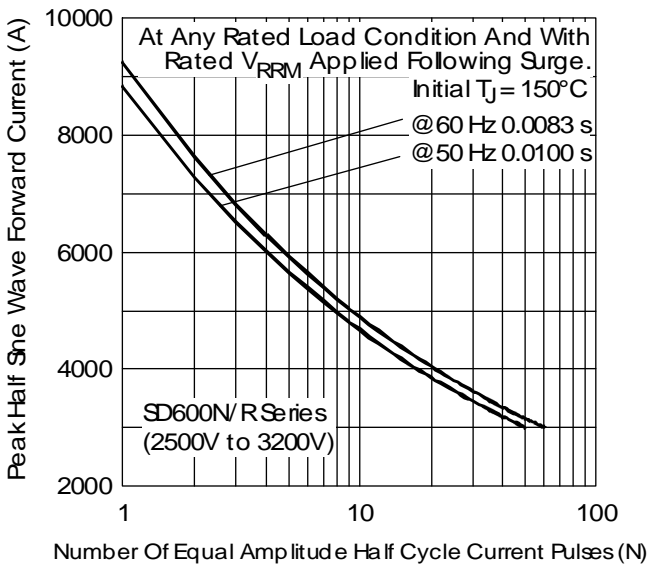

Fig. 11 - Maximum Non-Repetitive Surge Current

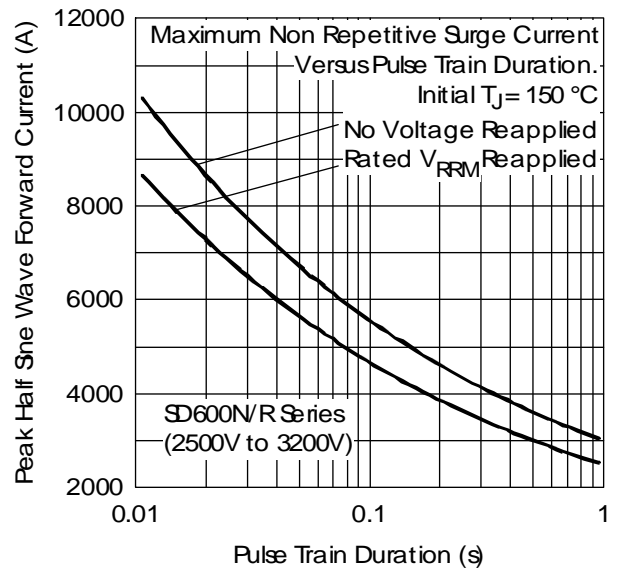

Fig. 12 - Maximum Non-Repetitive Surge Current

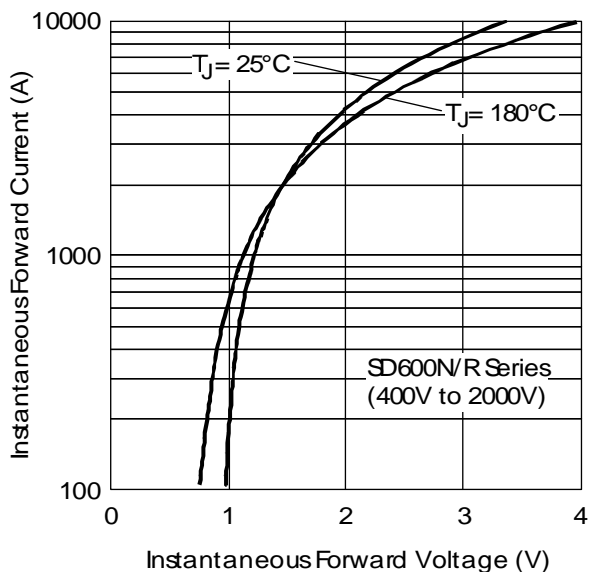

Fig. 13 - Forward Voltage Drop Characteristics

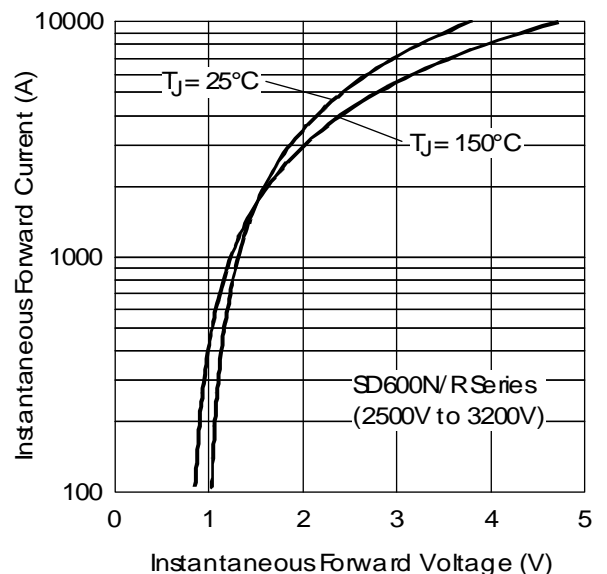

Fig. 14 - Forward Voltage Drop Characteristics

SD600N/R Series

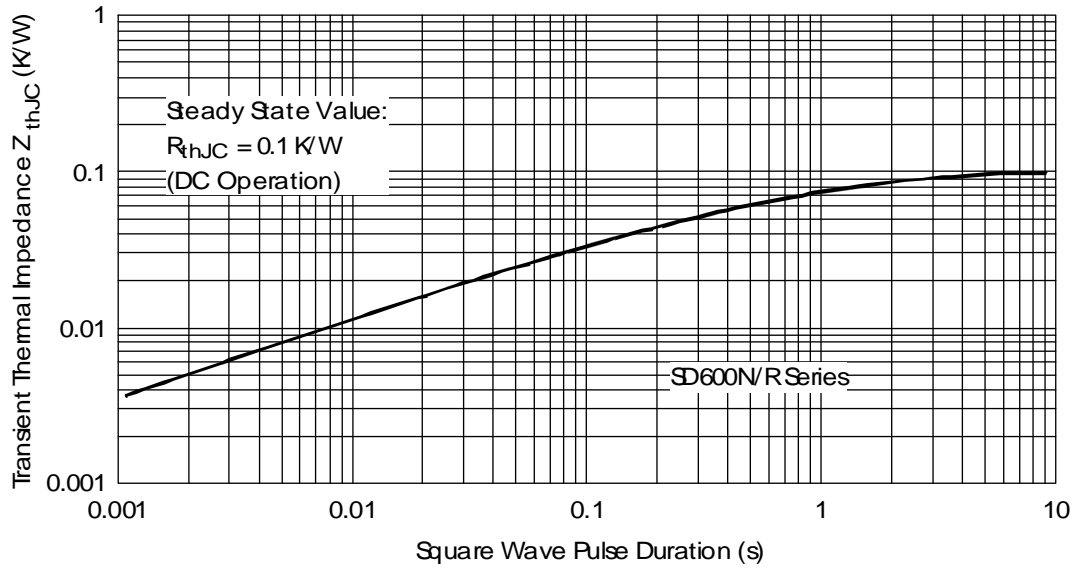

Fig. 15- Thermal Impedance Z_{thJC} Characteristics